

Gutter Profiles

Steeline FNW can produce a wide range of rainwater gutter profiles to fit your home or building design using quality Colorbond® or Zinalume® steel.



Compact Square Gutter ST17

Steeline FNW Compact Square Gutter is a stylish, modern profile that suits a wide variety of building designs.

- Manufactured from 0.42mm G550 Colorbond® or Zinalume® steel
- 310mm wide
- Can be made slotted or unslotted. Slots provide an overflow mechanism for the gutter
- Choice of dedicated GP Bracket or Gutter Spring Clip & Over Strap mounting systems
- Available per lineal metre up to 8m per length

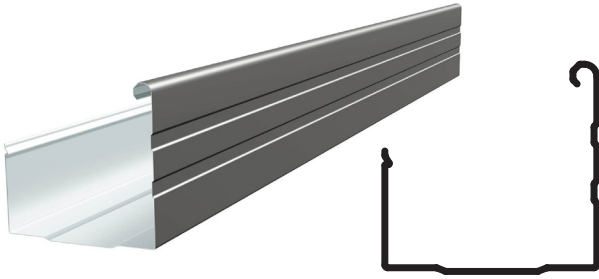

Heritage Gutter ST14

Steeline FNW Heritage Gutter profile pays homage to the design of old colonial style housing with a simple, yet intricate gutter profile.

- Manufactured from 0.42mm G550 Colorbond® or Zinalume® steel
- 310mm wide
- Can be made slotted or unslotted. Slots provide an overflow mechanism for the gutter
- Choice of dedicated GP Bracket or Gutter Spring Clip & Over Strap mounting systems
- Available per lineal metre up to 8m per length

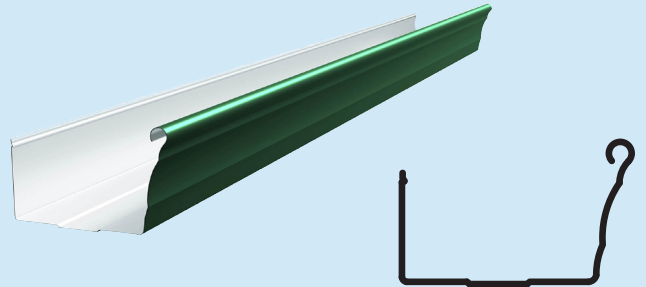

Quad 150 Low Front Gutter ST09

Steeline Quad Gutter is a traditional gutter shape that gives your home a modern look. The Quad 150 Low Front has a lower front, so your home can be protected from water overflow.

- Manufactured from 0.42mm G550 Colorbond® or Zinalume® steel
- 297mm wide
- Choice of dedicated GP Bracket or Gutter Spring Clip & Over Strap or Gutter Spike mounting systems
- Available per lineal metre up to 8m per length



Quad 125/150 High Front Gutter ST09

Steeline Quad Gutter is a traditional gutter shape that gives your home a modern look.

- Manufactured from 0.42mm G550 Colorbond® or Zinalume® steel
- Quad 125 - 280mm wide, Quad 150 - 310mm wide
- Can be made slotted or unslotted. Slots provide an overflow mechanism for the gutter
- Choice of dedicated GP Bracket, Gutter Spring Clip & Over Strap or Gutter Spike mounting systems
- Available per lineal metre up to 8m per length

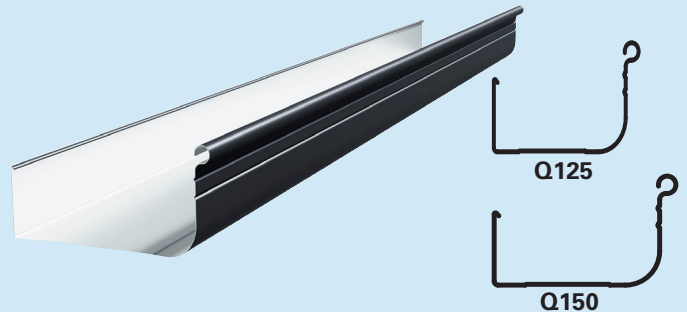

Quad 175 High Front Gutter ST09

Steeline Quad Gutter is a traditional gutter shape that gives your home a modern look. Quad 175 has high rainwater capacity.

- Manufactured from 0.42mm G550 Colorbond® or Zinalume® steel
- 340mm wide
- Can be made slotted or unslotted. Slots provide an overflow mechanism for the gutter
- Choice of dedicated GP Bracket, Gutter Clip & Over Strap or Gutter Spike mounting systems
- Available per lineal metre up to 8m per length



150 Half Round Gutter

Half Round Gutter is a popular profile that works well on all types of buildings. The 150mm diameter gives it good water carrying capacity.

- Manufactured from 0.42mm G550 Colorbond® or Zinalume® steel
- 138mm wide
- Can be made slotted or unslotted. Slots provide an overflow mechanism for the gutter
- Mounts with a tailor-made external bracket
- Available per lineal metre up to 8m per length

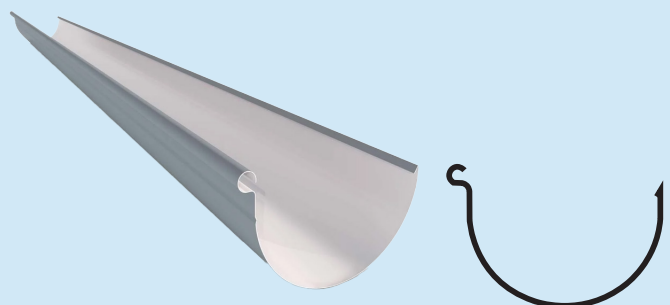

SquareMAX 125 Gutter

SquareMax Gutter is an appealing, modern profile with a rollformed rib and slots on the front face, offering great resistance to denting and a stylish, buckle free appearance.

- Manufactured from 0.42mm G550 Colorbond® or Zinalume® steel
- Can be made slotted or unslotted. Slots provide an overflow mechanism for the gutter
- Choice of dedicated GP Bracket or Gutter Clip & Over Strap mounting systems
- Available per lineal metre up to 8m per length

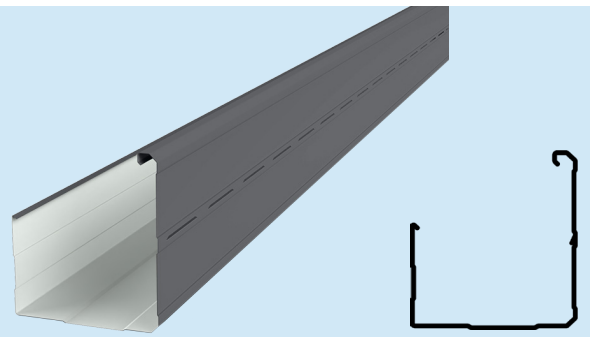

Round Flo Gutter

Round Flo Gutter looks very similar to half round but has a flat back making it easy to mount with GP Brackets or Gutter Springs.

- Manufactured from 0.42mm G550 Colorbond® or Zinalume® steel
- 138mm wide
- Can be made slotted or unslotted. Slots provide an overflow mechanism for the gutter
- Can be mounted with a Timber Fix Clip (wood fascia only) or Gutter Clip & Internal Strap mounting system
- Available per lineal metre up to 8m per length

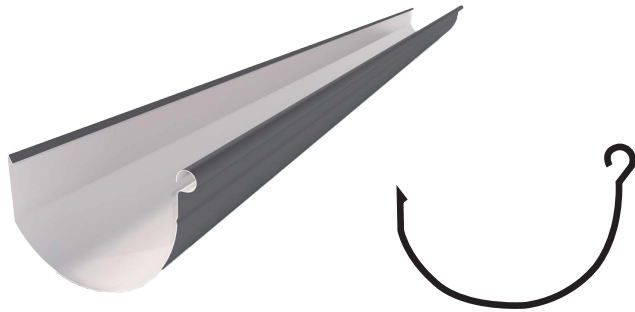

Full Range of accessories to suit your gutter profiles

Finishing and Mounting Systems

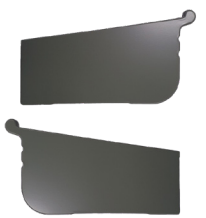

Gutter Stop Ends



GP Brackets



Over Straps



Spring Clips



Gutter Spikes

Nozzles/Drops



Rectangular



Uni-Drop
(Rectangular or Round)



Half Round
Gutter Nozzle



Round
50mm ~ 150mm

Downpipes

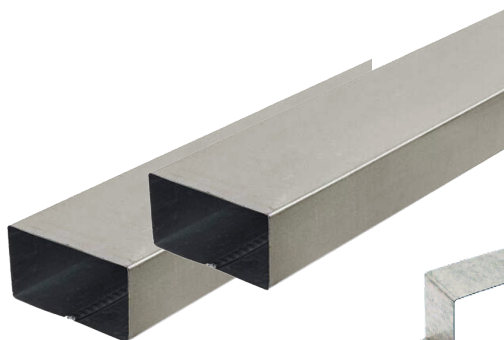

Downpipes

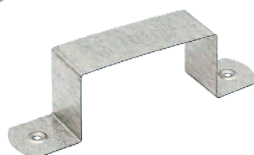

Downpipe Straps

Rain Heads & Sumps



Rain Heads
(varying capacities)

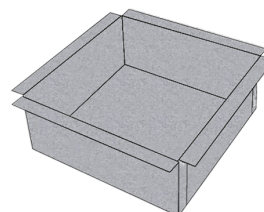

Rain Sumps
(varying capacities)

COLOUR YOUR GUTTER

Of all the elements of design, colour is the most powerful and personal. The COLORBOND® steel colour palette makes it easy to express yourself with colour. Steeline FNW provides you with a huge colour range to choose from which have been inspired by Australia's own magnificent backyard.

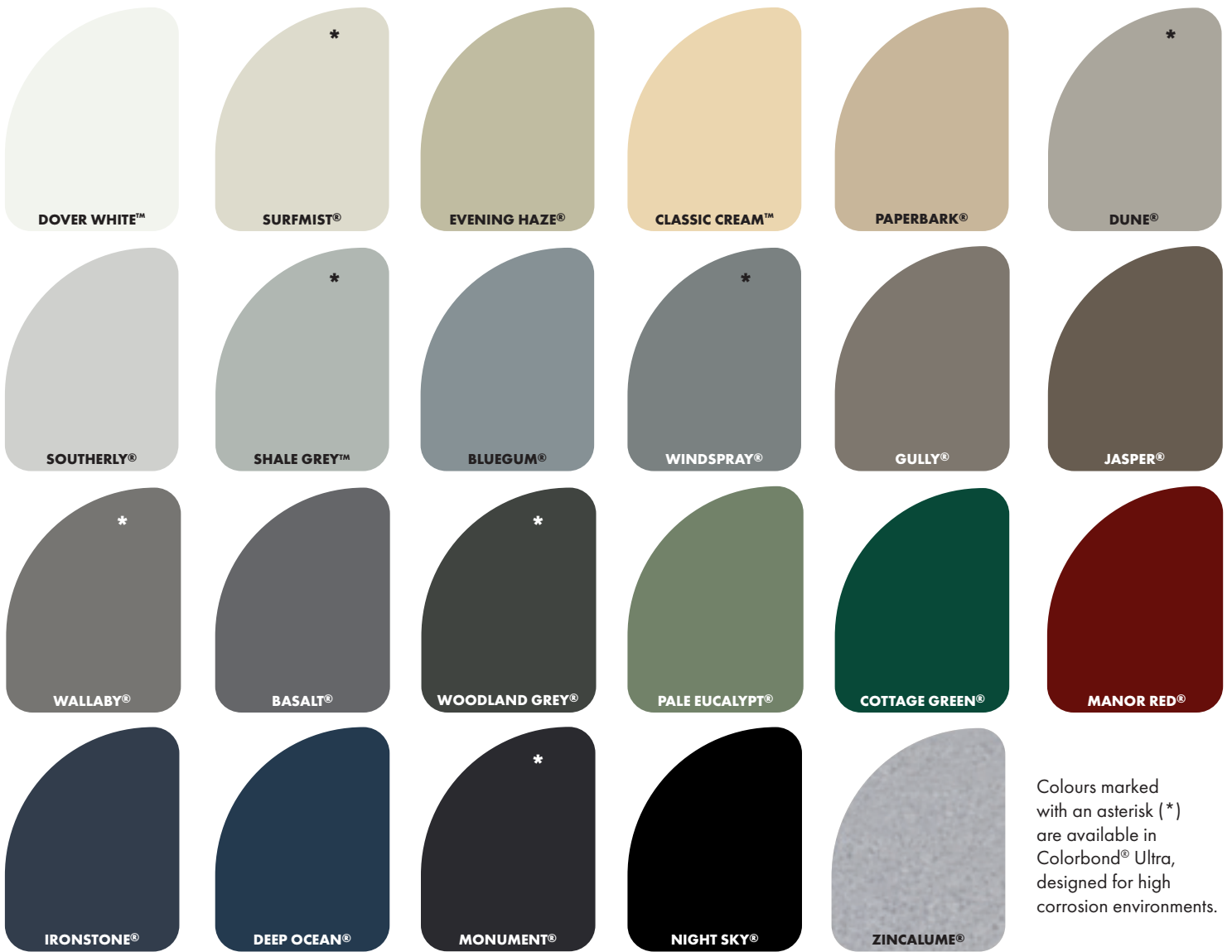

COLORBOND® MATT

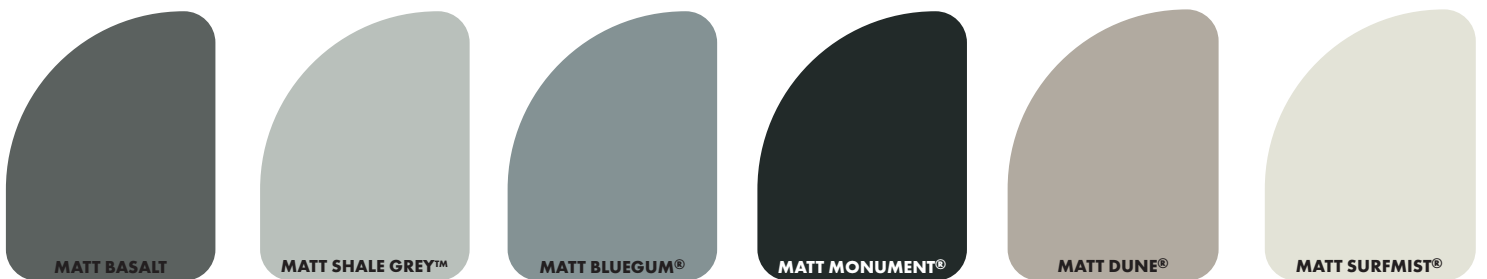

The COLORBOND® steel colour swatches in this brochure have been reproduced to represent actual product colours as accurately as possible. However we recommend checking your chosen colour against an actual sample of the product before purchasing, as varying light conditions and limitations of the printing process may affect colour tones. COLORBOND® ZINCALUME® and ® colour names are registered trade marks of BlueScope Steel Limited. ™ colour names are trade marks of BlueScope Steel Limited. ABN 16 000 011 058. All rights reserved.

Colorbond®

Zincalume®

1300 BUY STEEL
fnw.com.au

BRISBANE

36-54 Badu Court
Meadowbrook QLD 4131

P: (07) 3200 8122

E: brisbane@fnw.com.au

TOOWOOMBA

300 Anzac Avenue
Harristown QLD 4350

P: (07) 4580 4244

E: toowoomba@fnw.com.au

INVERELL

84 Oliver Street
Inverell NSW 2360

P: (02) 6722 4593

E: inverell@fnw.com.au